

VINCE.

BOM ILLUSTRATION MANUAL
FALL 2023 - WOMENS

DATE ISSUED: 3/21/23
UPDATES: NEW FOLDING METHOD (BOBI 21199)

MAIN LABELS-OUTERWEAR JACKETS

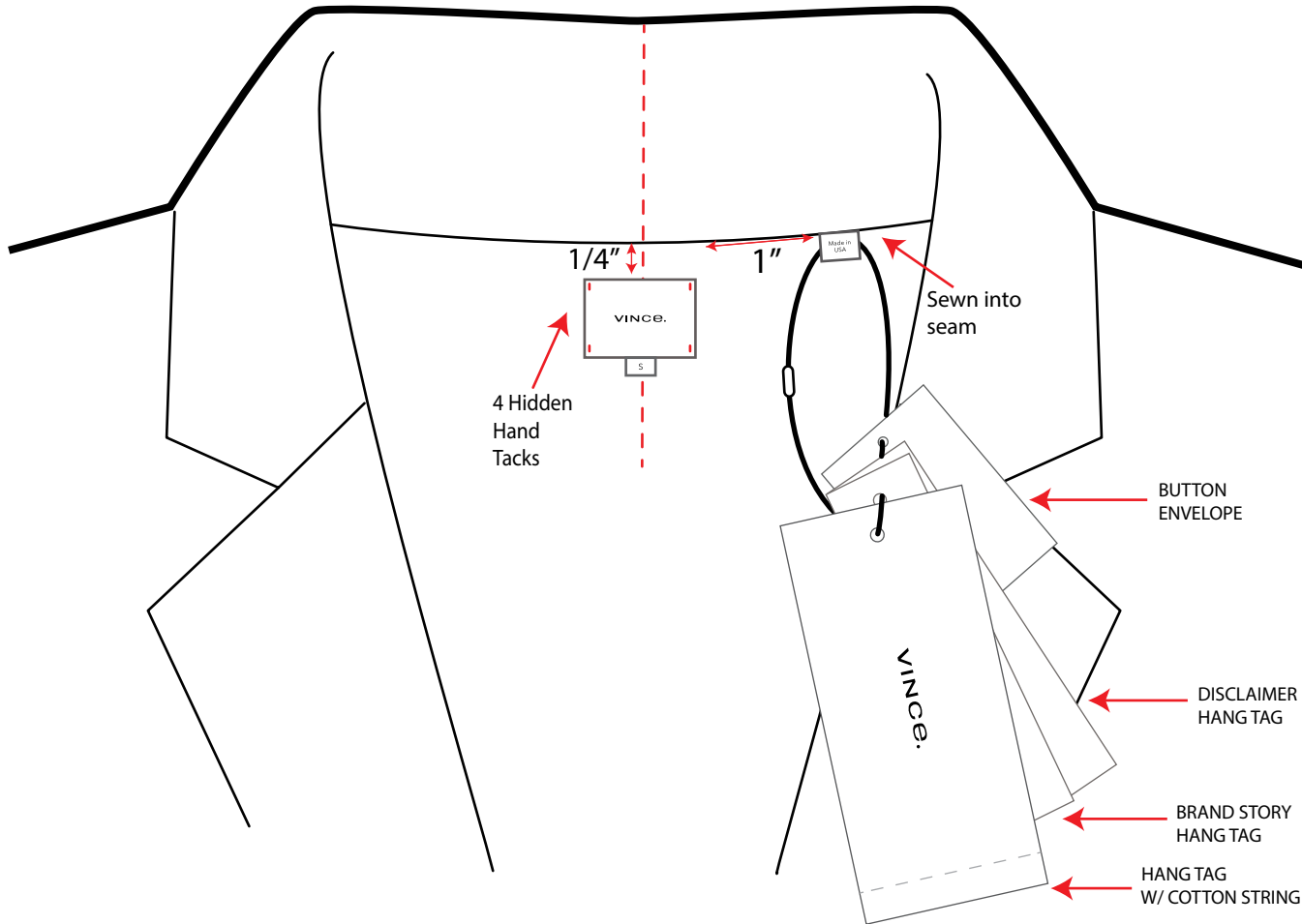

LEGEND:

Main Label



Size Label



COO Label



Hang Tag

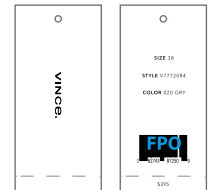

Brand Story Hang Tag



Disclaimer Hang Tag



Button Envelope:

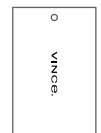

MAIN LABELS-OUTERWEAR BLAZERS

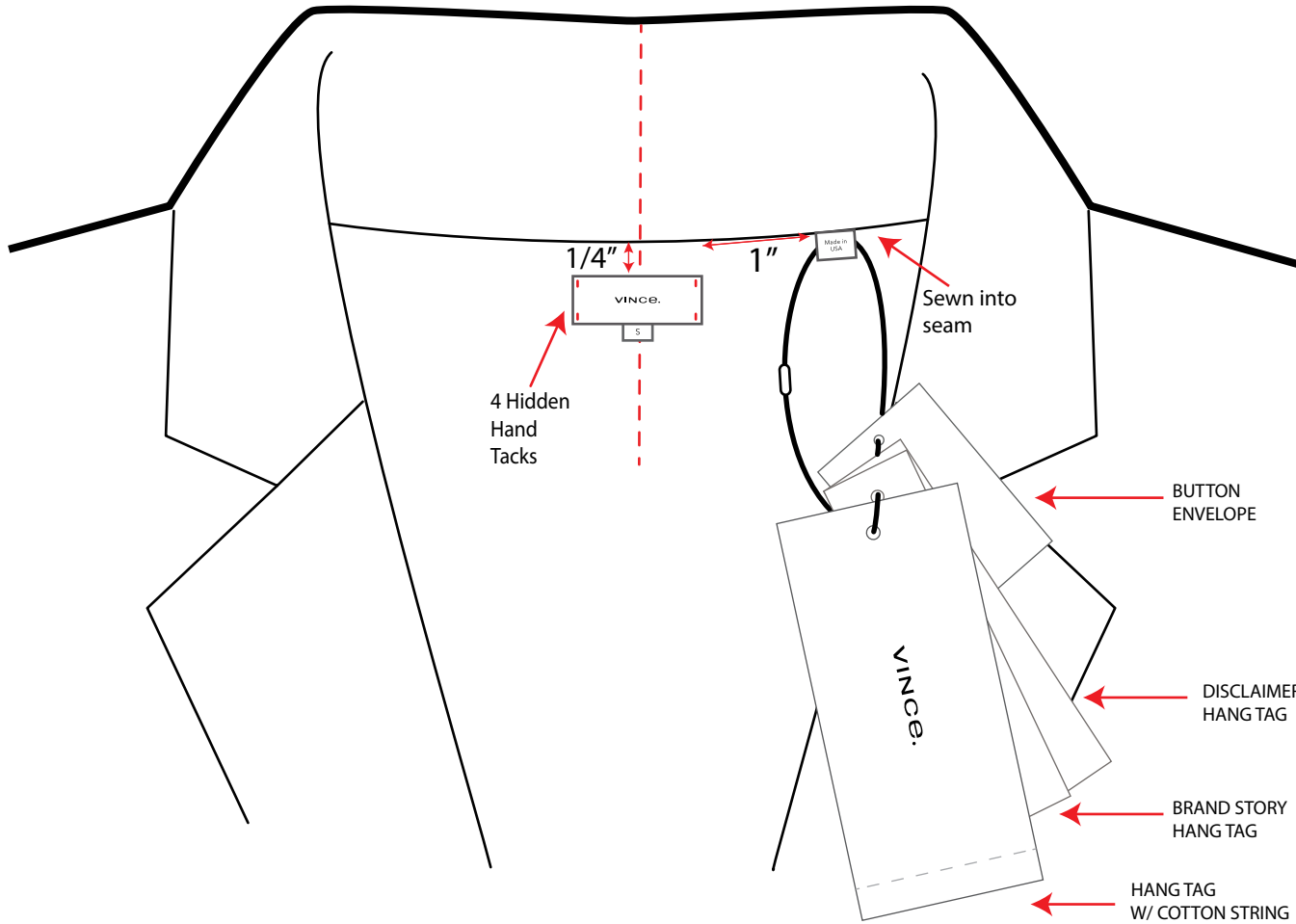

LEGEND:

Main Label



Size Label



COO Label



Hang Tag



Brand Story Hang Tag



Disclaimer Hang Tag



Button Envelope:

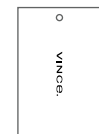

MAIN LABELS-OUTERWEAR SHEARLING & FUR COATS

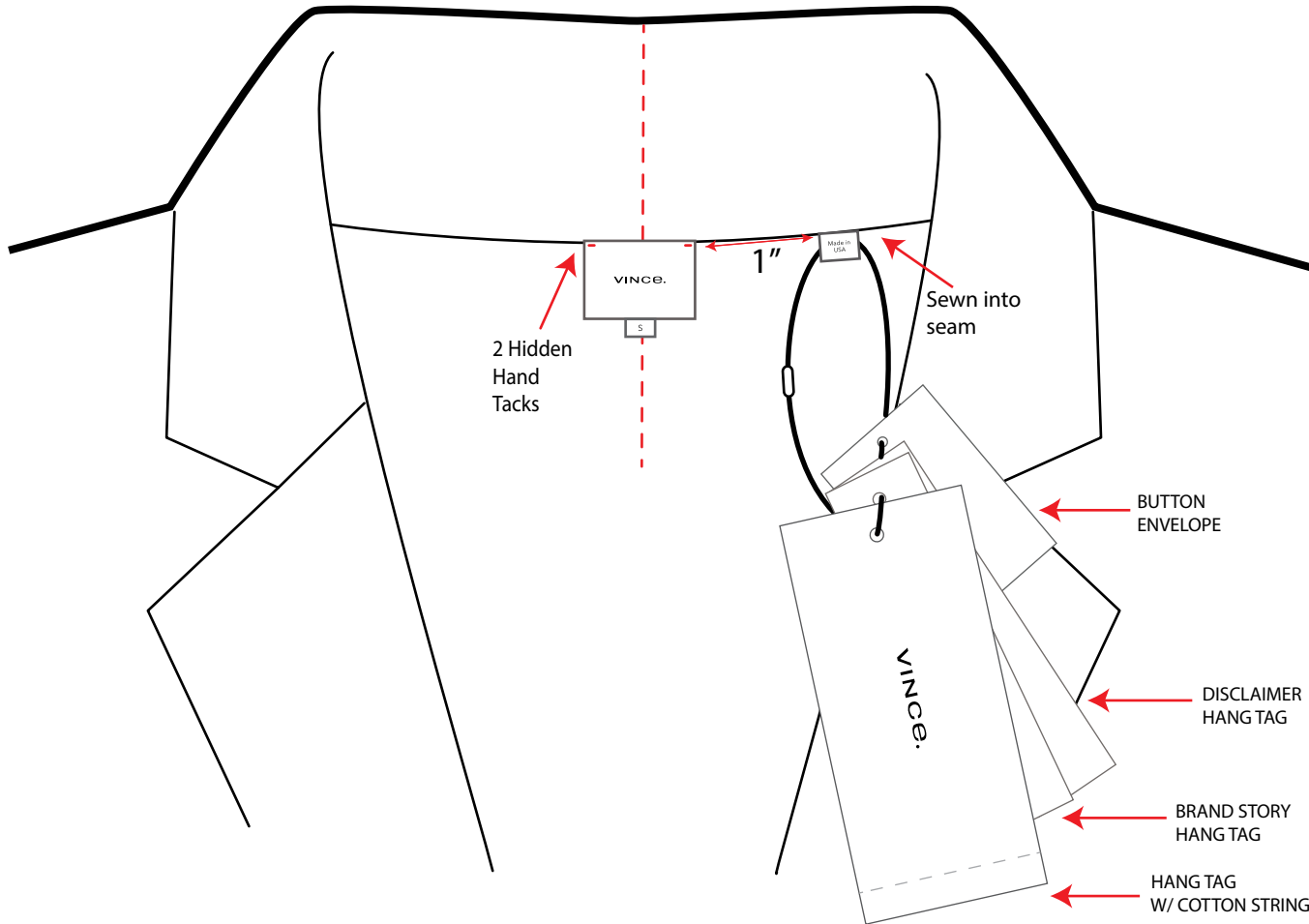

LEGEND:

Main Label



Size Label



COO Label



Hang Tag



Brand Story Hang Tag



Disclaimer Hang Tag



Button Envelope:



MAIN LABELS-OUTERWEAR SHEARLING & FUR COATS

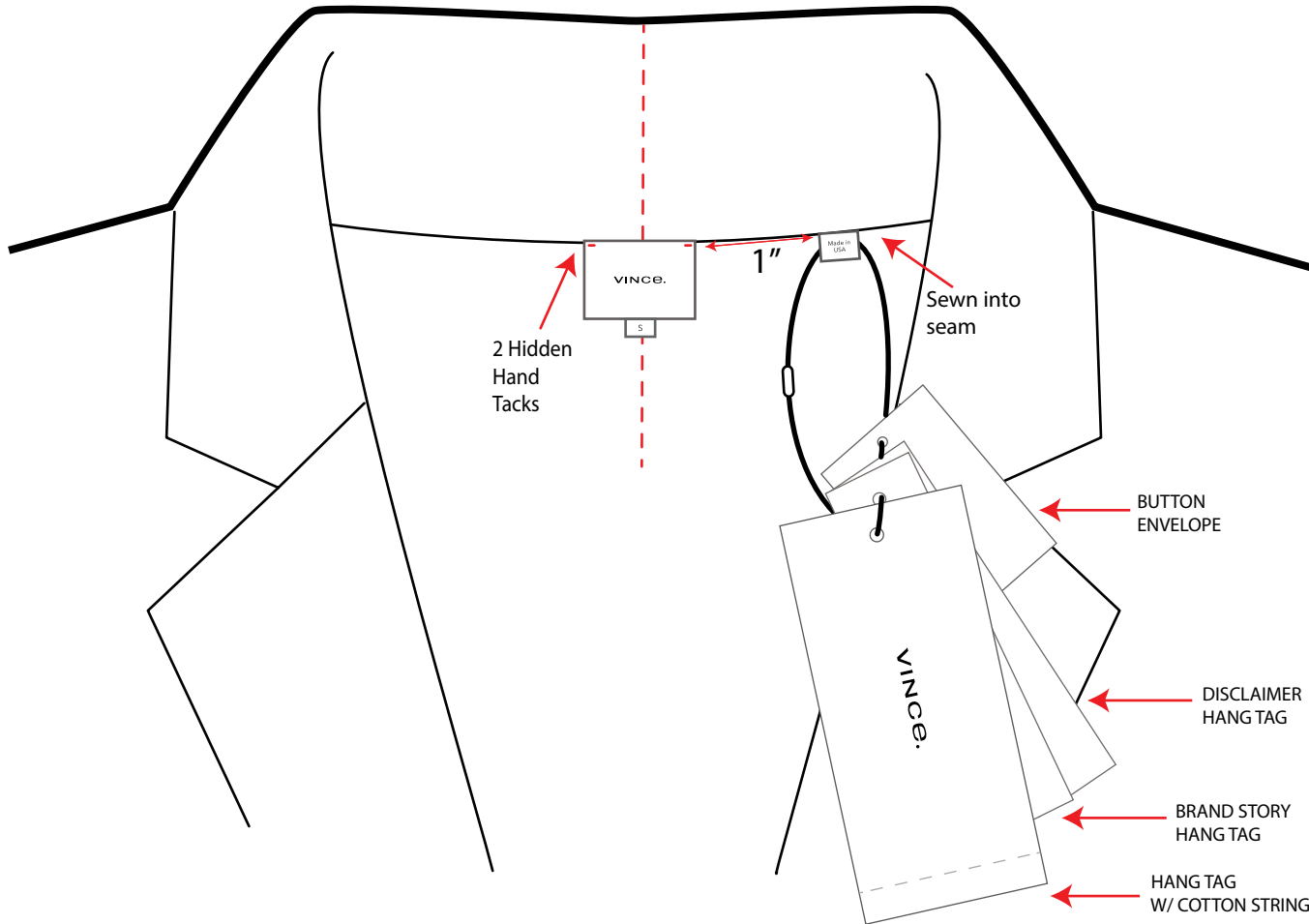

LEGEND:

Main Label



Size Label



COO Label



Hang Tag

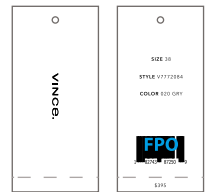

Brand Story Hang Tag



Disclaimer Hang Tag

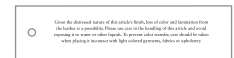

Button Envelope:

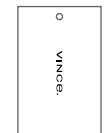

MAIN LABELS- SOFT WOVENS WITH CB ZIPPER WITH BACK FACING

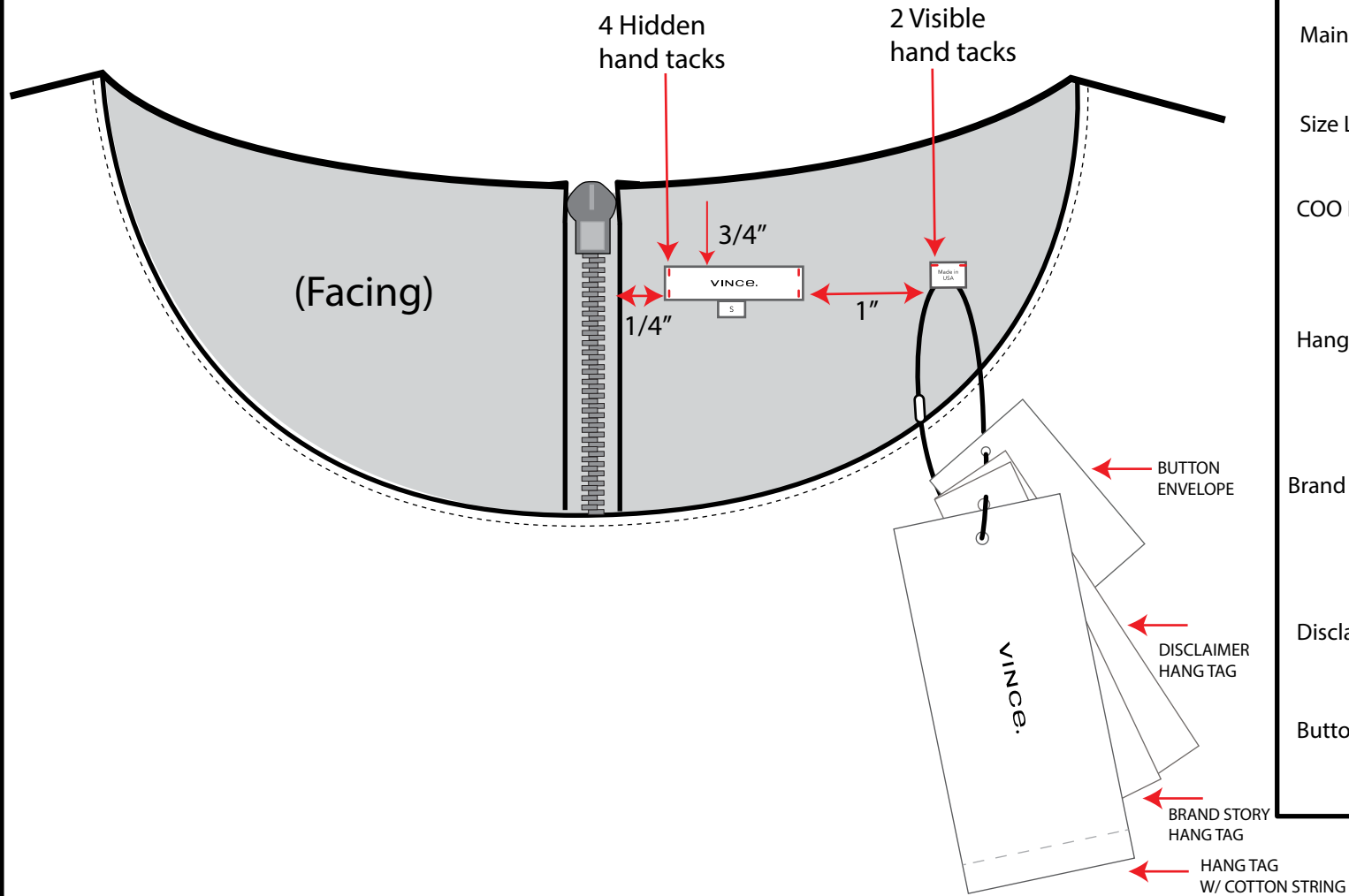





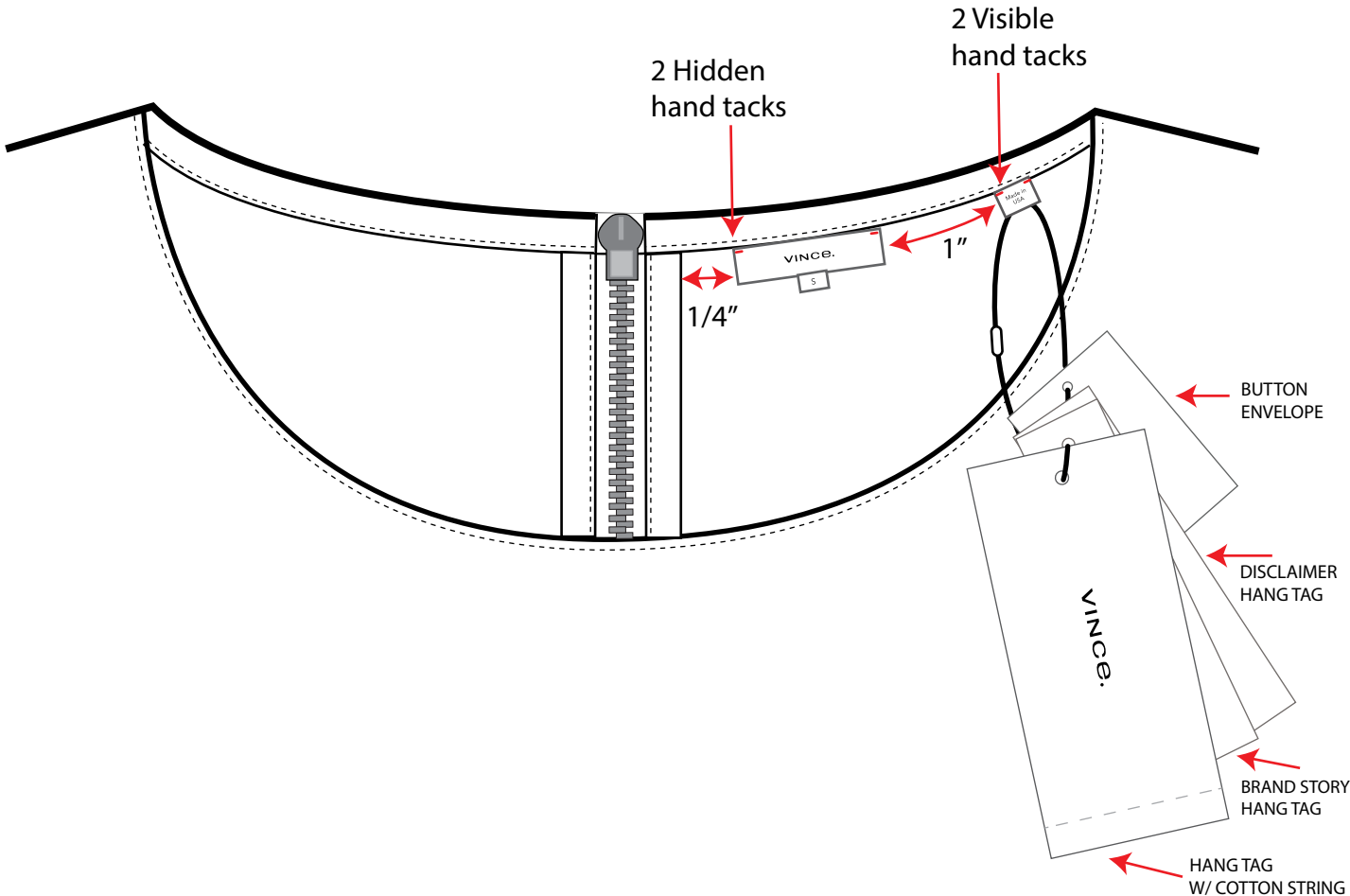

LEGEND:

- Main Label**: VINCE.
- Size Label**: S
- COO Label**: Made in USA
- Hang Tag**: VINCE. (vertical), SIZE 38, STYLE V7772084, COLOR 020 GRV, FPQ, 8195
- Brand Story Hang Tag**: BRAND STORY
- Disclaimer Hang Tag**: Made in Los Angeles, Vince creates clothing... (text continues)
- Button Envelope**: VINCE.

MAIN LABELS- SOFT WOVENS WITH CB ZIPPER WITH INTERIOR BINDING

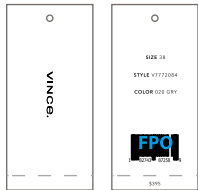

LEGEND:

- Main Label:** 
- Size Label:** 
- COO Label:** 
- Hang Tag:** 
- Brand Story Hang Tag:** 

- Disclaimer Hang Tag:** 
- Button Envelope:** 

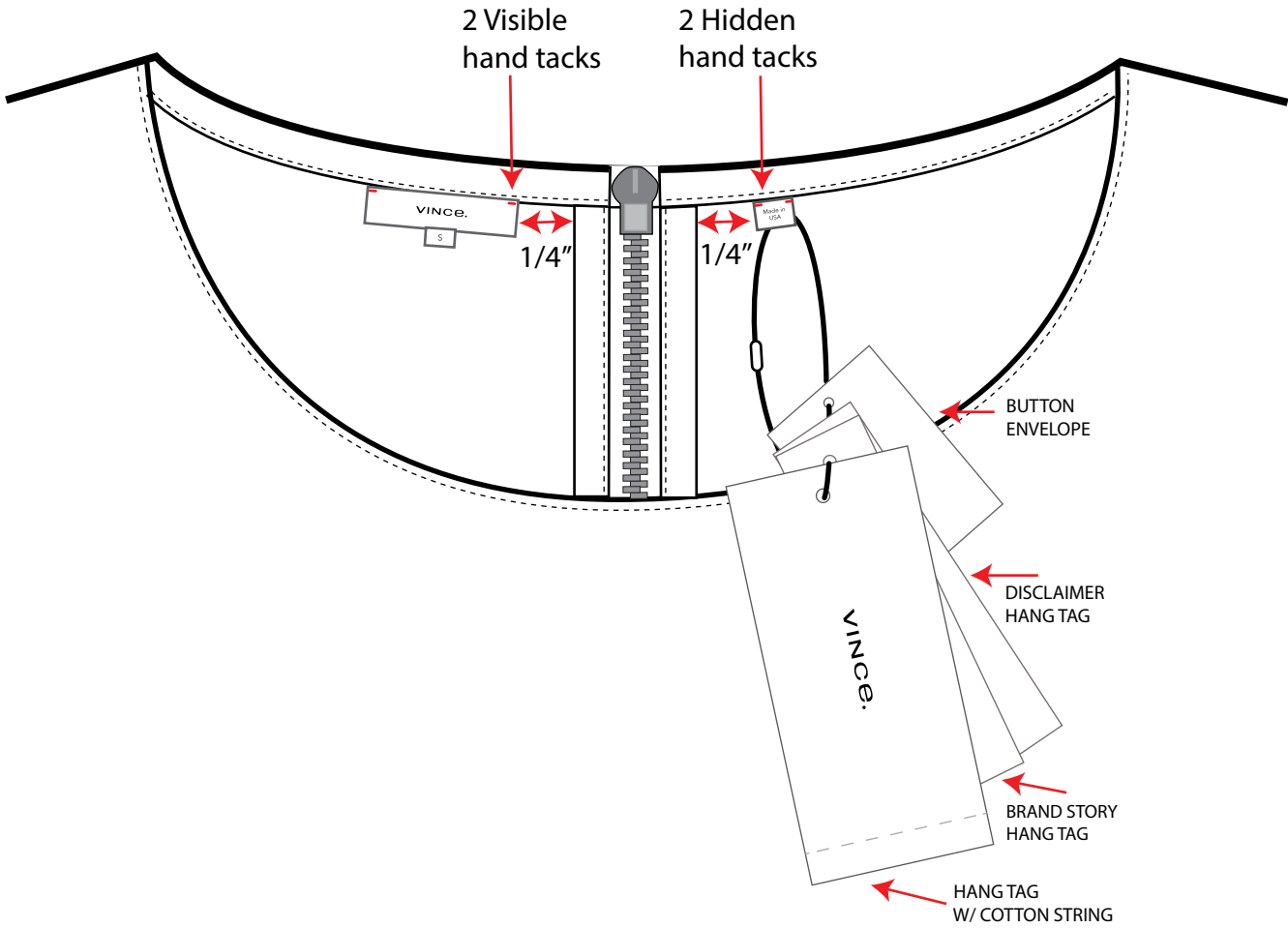
MAIN LABELS- SOFT WOVENS CREW NECK WITH CB ZIPPER WITH INTERIOR BINDING



LEGEND:

Main Label



Size Label



COO Label



Hang Tag

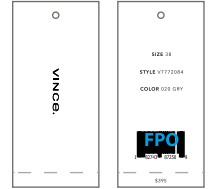

Brand Story Hang Tag



Disclaimer Hang Tag

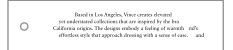

Button Envelope:

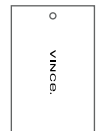

MAIN LABELS- SOFT WOVENS WITH INTERIOR BINDING

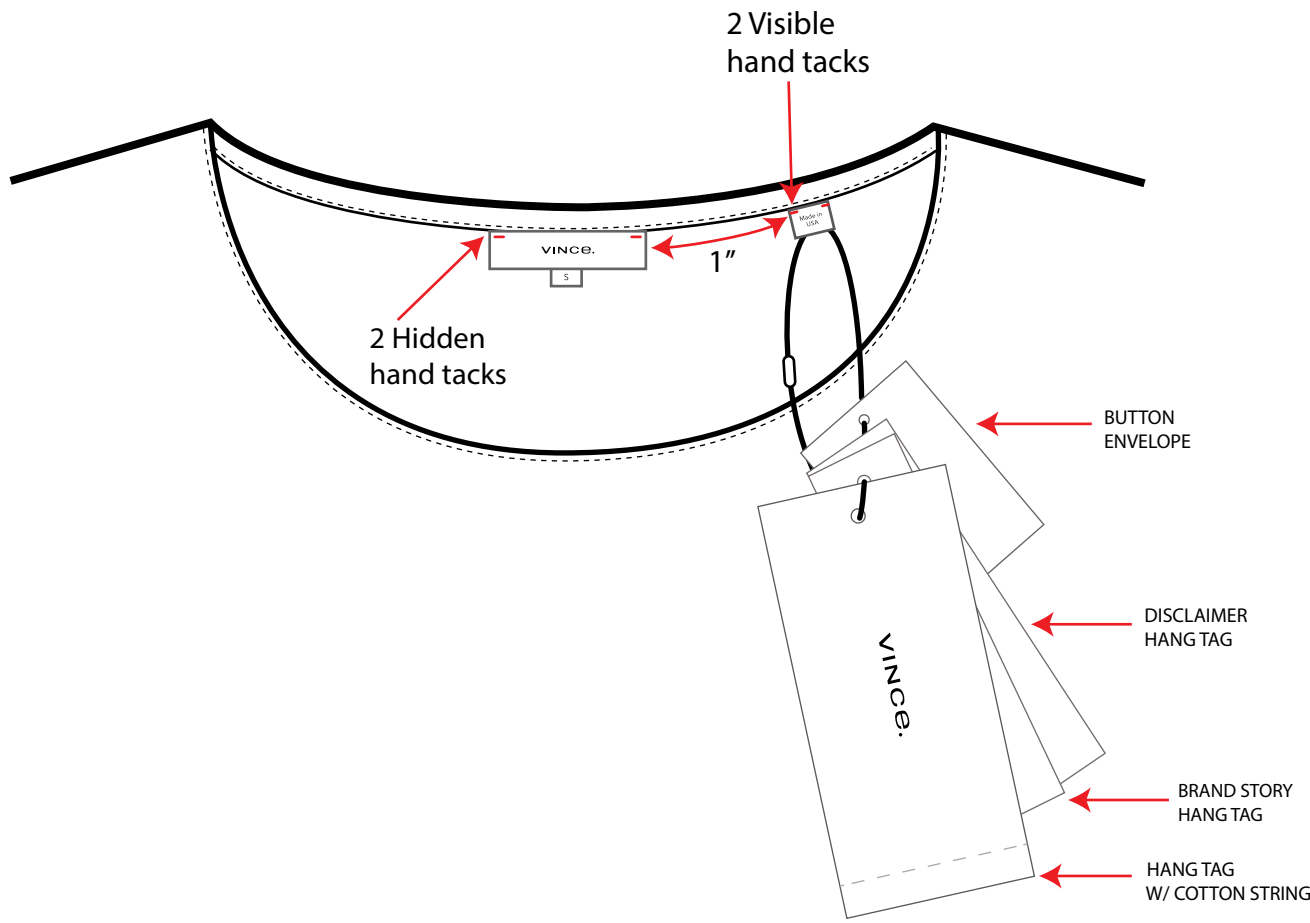

LEGEND:

Main Label: VINCE.

Size Label: S

COO Label: Made in USA

Hang Tag: VINCE. SIZE IT STYLE 11772084 COLOR 022 D07 FPO

Brand Story Hang Tag: BRAND STORY

Disclaimer Hang Tag: Based in Los Angeles, Vince creates elevated, yet minimalist, silhouettes that are inspired by the Los Angeles region. The design reflects a blend of modern, soft silhouettes with their approach-driven with a sense of ease and

Button Envelope: VINCE.

MAIN LABELS- SOFT WOVENS

ALL FABRICATIONS WITH DOUBLE YOKE, TOP LAYER ONLY

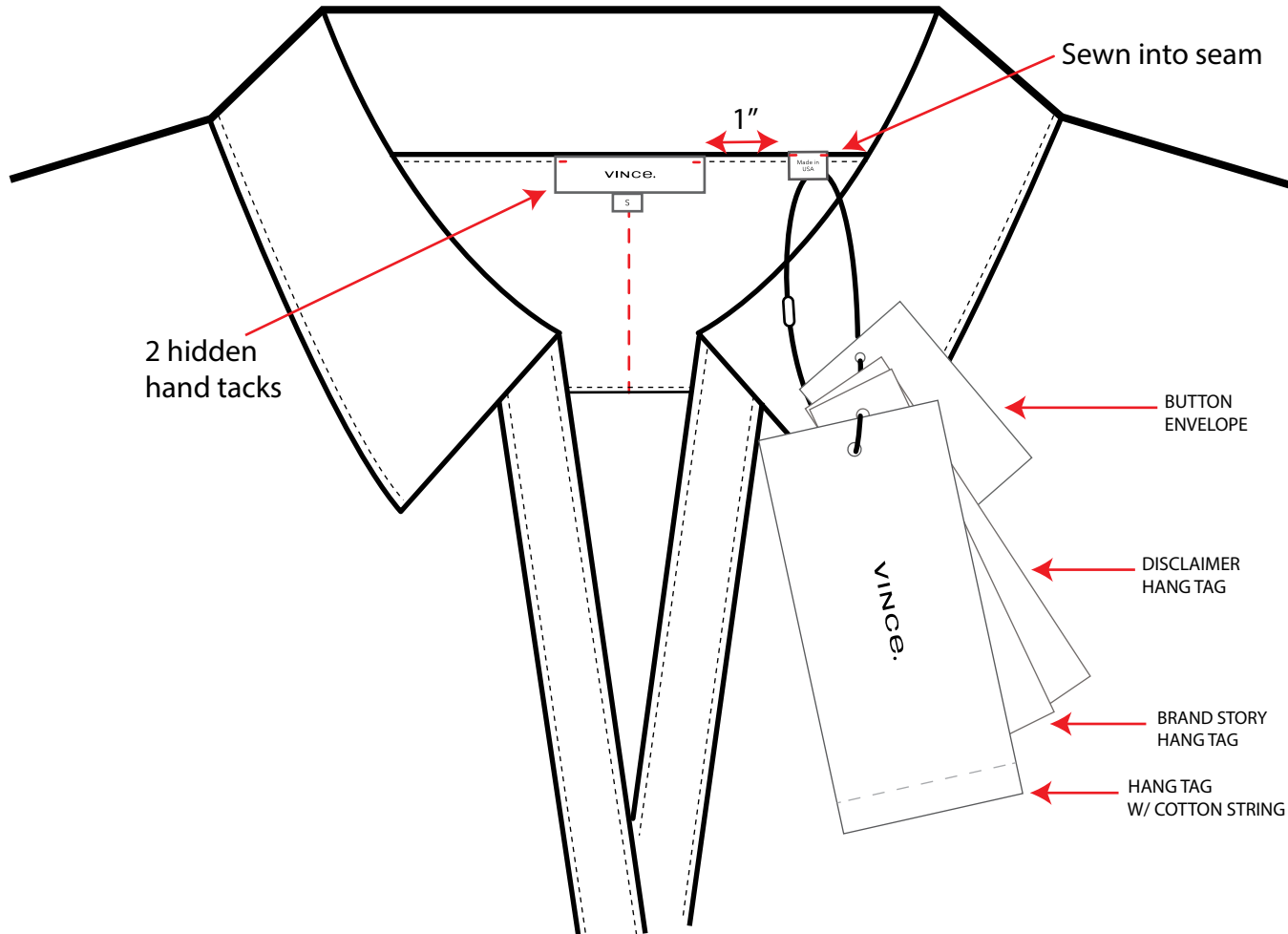

LEGEND:

Main Label



Size Label



COO Label



Hang Tag

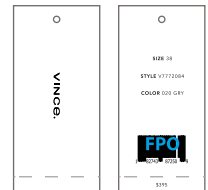

Brand Story Hang Tag



Disclaimer Hang Tag

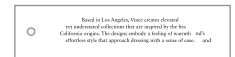

Button Envelope:

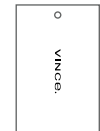

MAIN LABELS- BOTTOMS- FRONT ZIP FLY

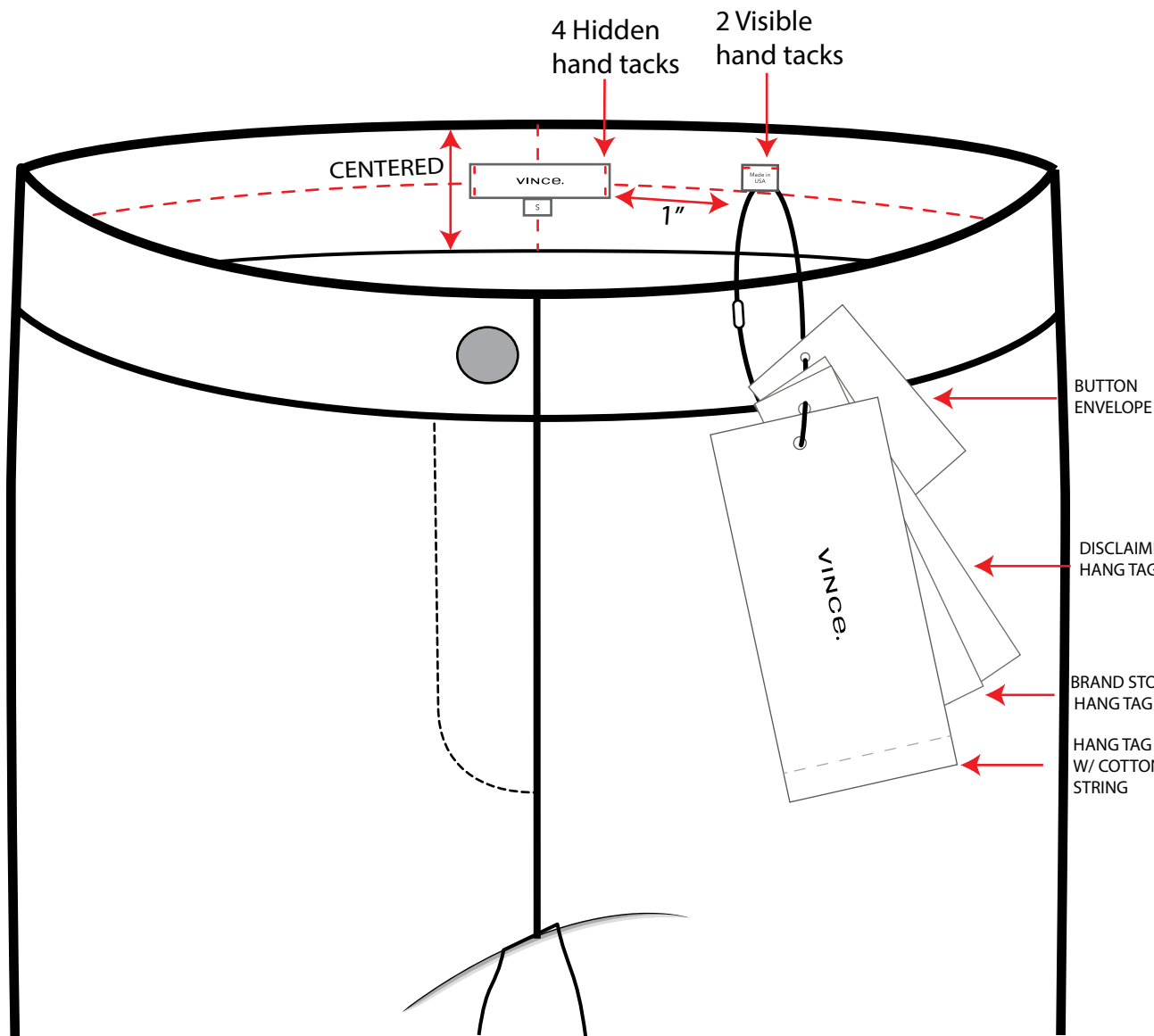

LEGEND:

Main Label



Size Label



COO Label



Hang Tag



Brand Story Hang Tag



Disclaimer Hang Tag

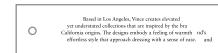

Button Envelope:



MAIN LABELS-BOTTOM-CB ZIPPER

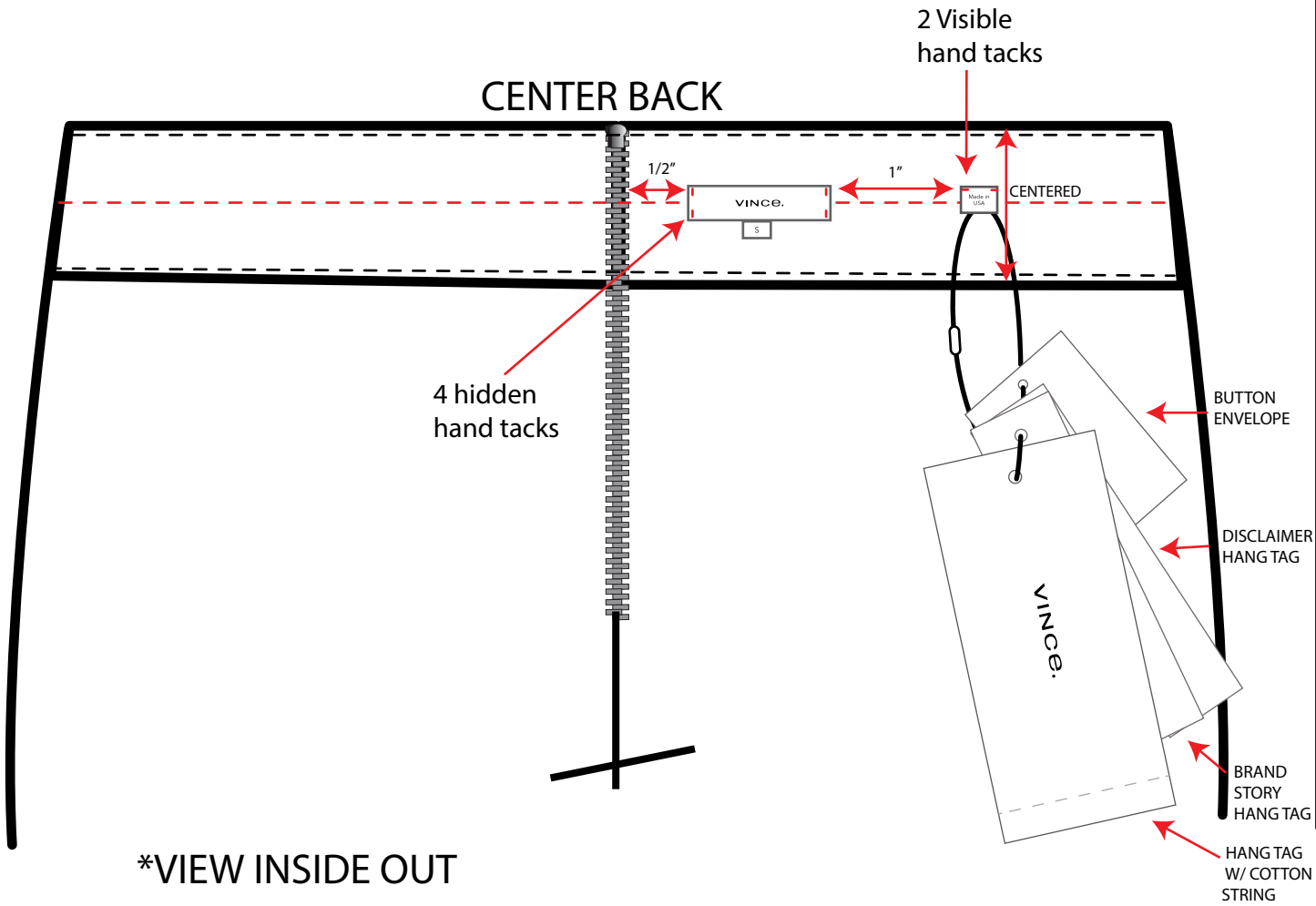

LEGEND:

Legend defining the visual elements used in the diagram:

- Main Label:** A rectangular box containing "VINCE." and "S" below it.
- Size Label:** A small square box containing "S".
- COO Label:** A rectangular box containing "Made in USA".
- Hang Tag:** Two vertical rectangular tags. The left one has "VINCE." written vertically. The right one contains: "SIZE: M", "STYLE: V772284", "COLOR: 810 GUY", and "FPO" in a blue box.
- Brand Story Hang Tag:** A rectangular box containing "BRAND STORY" and a small circular icon.
- Disclaimer Hang Tag:** A rectangular box containing a disclaimer text: "Based in Los Angeles, Vince creates curated, on-demand collections that are inspired by the best California designs. The designs are made-to-order, and all attributes reflect the approach: dressing with a sense of ease. and".
- Button Envelope:** A vertical rectangular box containing "VINCE." and a small circular icon.

MAIN LABELS-BOTTOMS WITH SIDE ZIPPER WITH INTERIOR BINDING

CENTER BACK

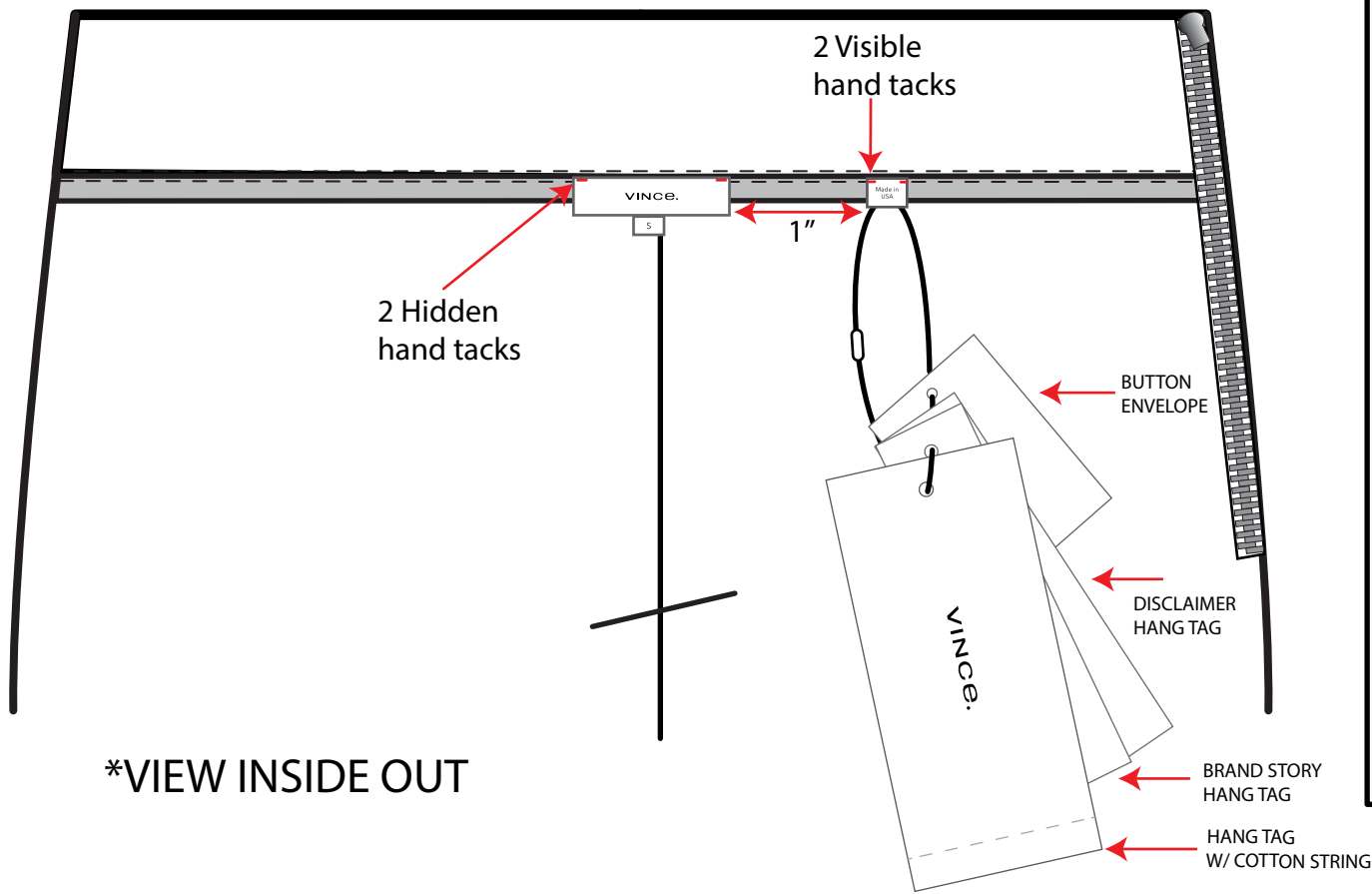

*VIEW INSIDE OUT

LEGEND:

Main Label



Size Label



COO Label



Hang Tag

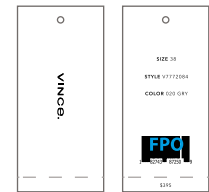

Brand Story Hang Tag



Disclaimer Hang Tag

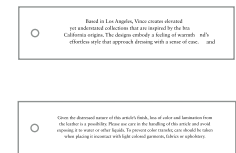

Button Envelope:

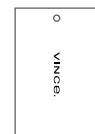

MAIN LABELS- BOTTOMS LEATHER WITH CB ZIPPER BINDING AT WAISTBAND FACING

*VIEW INSIDE OUT

2 Hidden
hand tacks

2 Visible
hand tacks

1/2"

1"

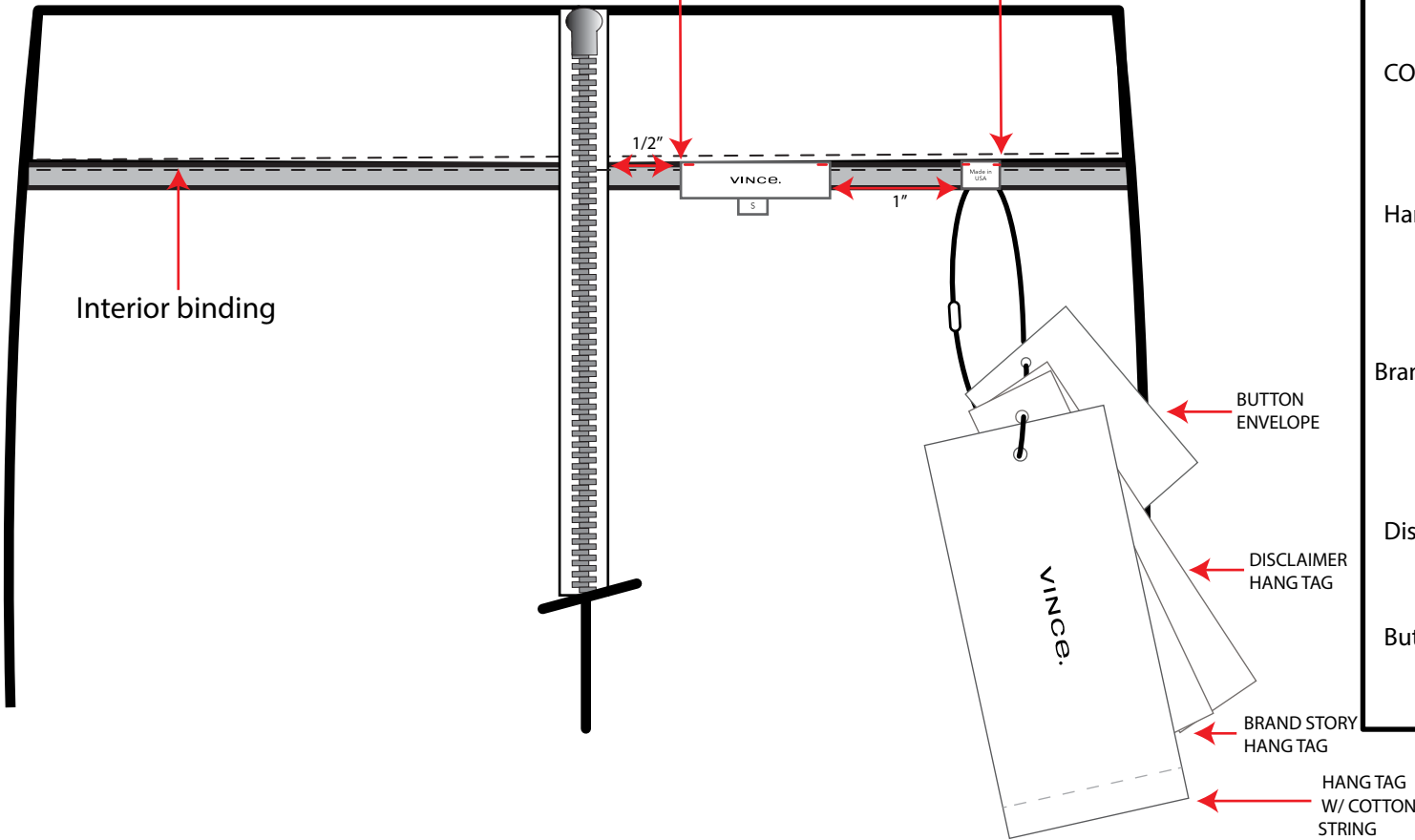

LEGEND:

Main Label



Size Label



COO Label



Hang Tag



Brand Story Hang Tag



Disclaimer Hang Tag



Button Envelope:



MAIN LABELS - BOTTOMS WITH ELASTIC WAISTBAND

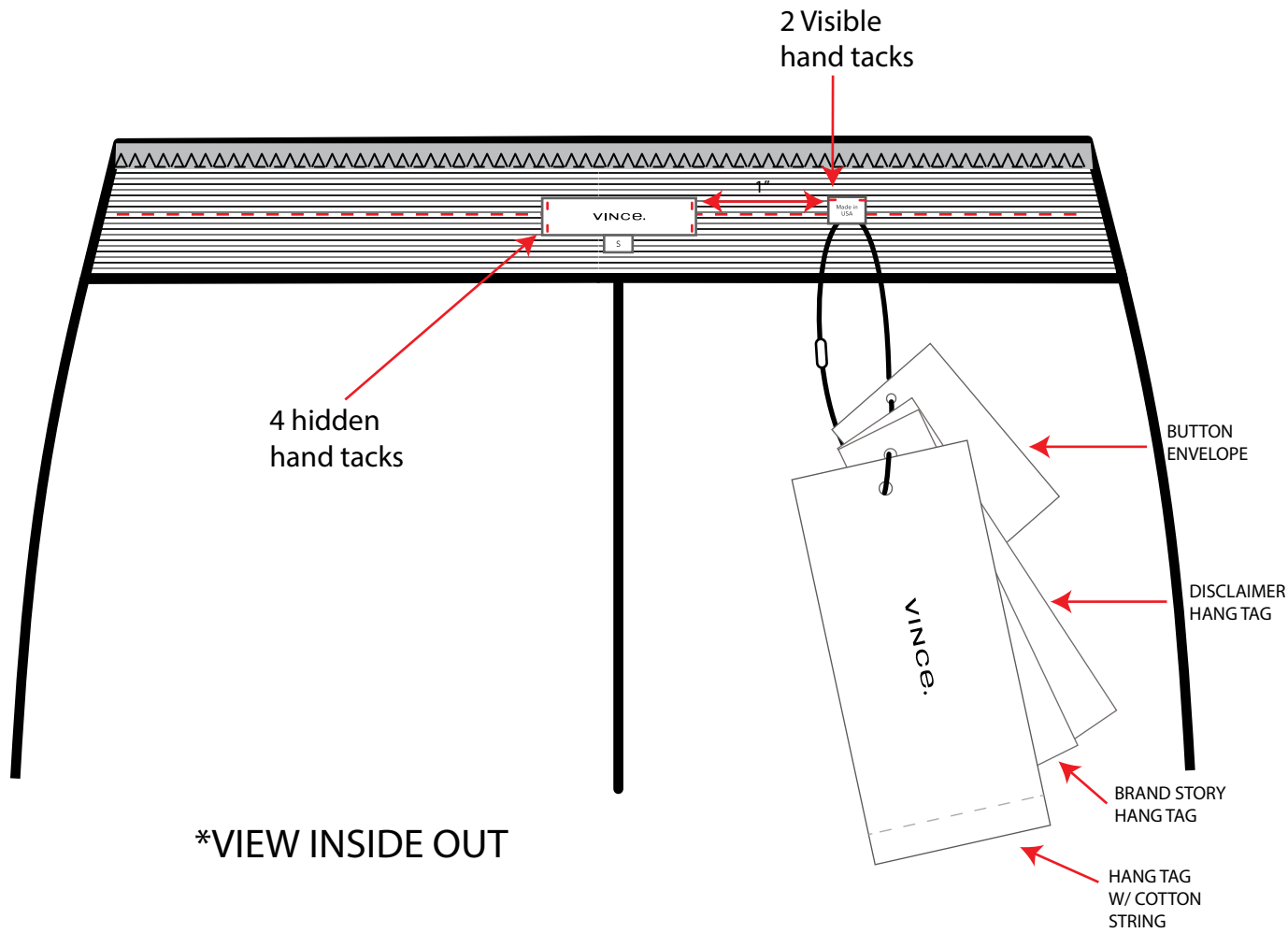

LEGEND:

Main Label



Size Label



COO Label



Hang Tag

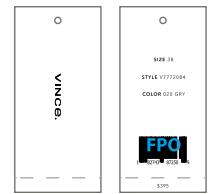

Brand Story Hang Tag



Disclaimer Hang Tag



Button Envelope:

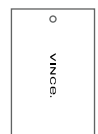

MAIN LABELS- BOTTOMS WITH ELASTIC WAISTBAND

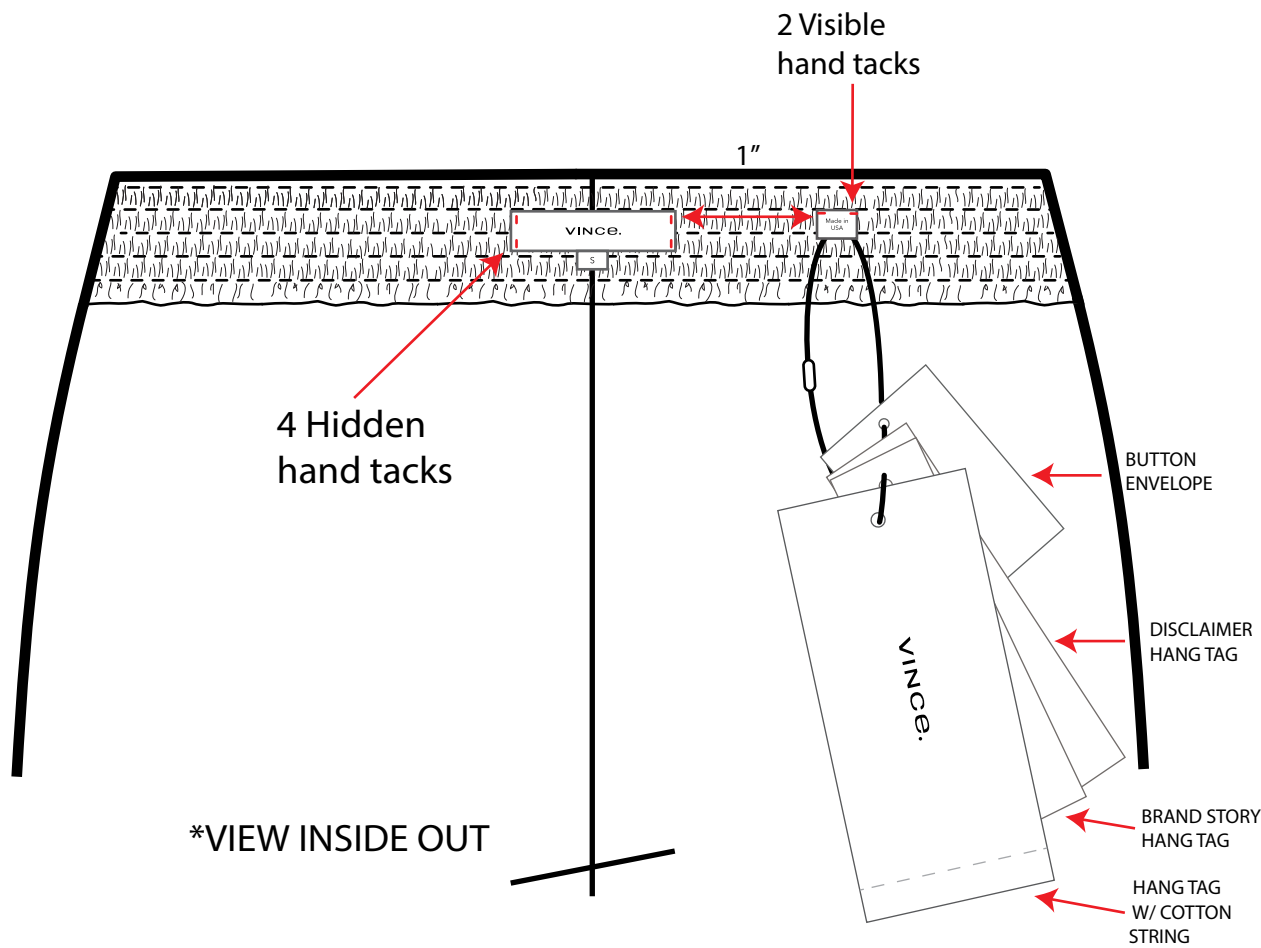

LEGEND:

Main Label



Size Label



COO Label



Hang Tag

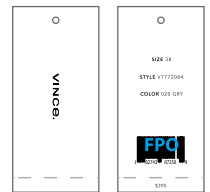

Brand Story Hang Tag



Disclaimer Hang Tag



Button Envelope:

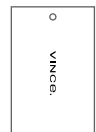

BI-FOLD- CASUAL WOVEN SHORTS

1. Fold short back to back with fold at rise.

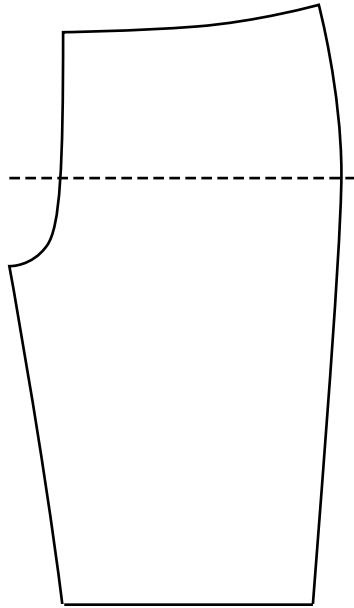

2. Fold short leg up once at thigh.

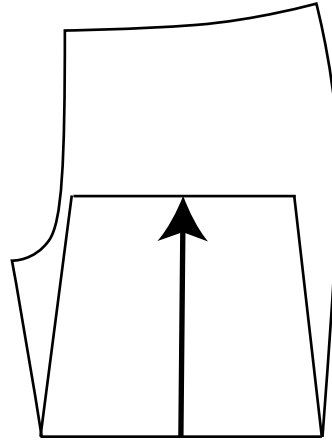

3. Wearer's right faced up.

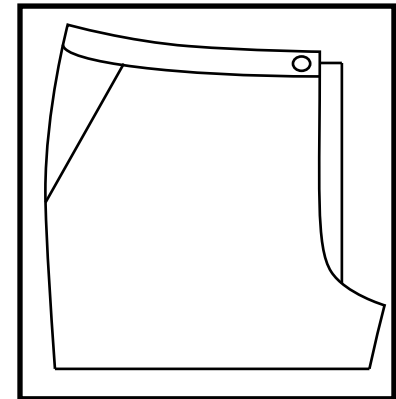

BI-FOLD- BOBI 21199

1. Fold pant front to front with fold at rise. Pull crotch point out and smooth leg.



2. Place foam stick at fold. Fold Pant leg in half - bottom edge to waist band.



3. Wearer's left faced up.



Foam Sticks
1 1/4" x 8"



TRI-FOLD- CASUAL WOVEN BOTTOMS

1. Fold pant back to back with fold at rise.

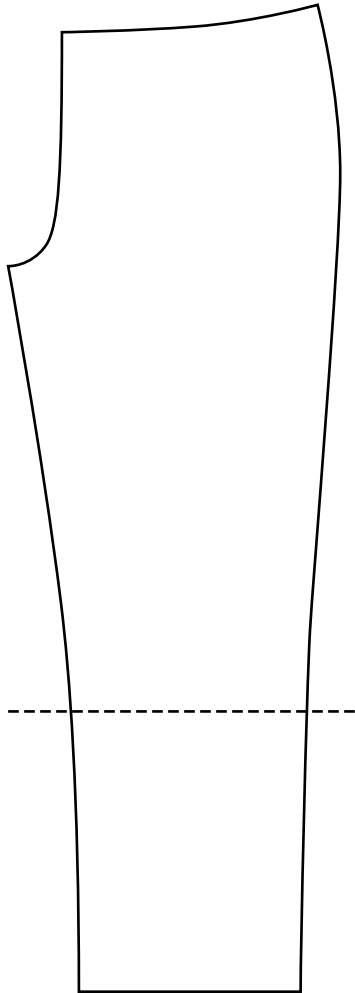

2. Fold pant leg in thirds - bottom edge to above knee then fold up to waist top edge.

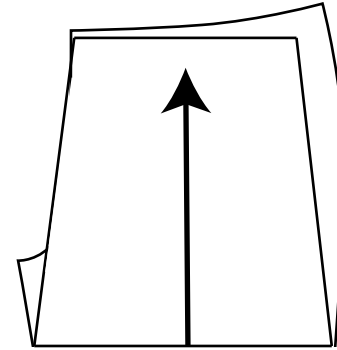
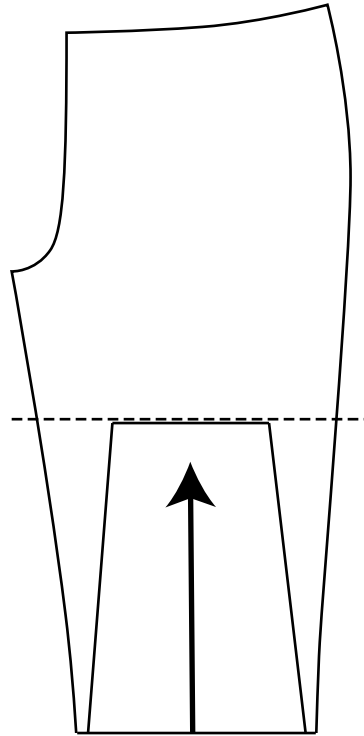

3. Wearer's right faced up.

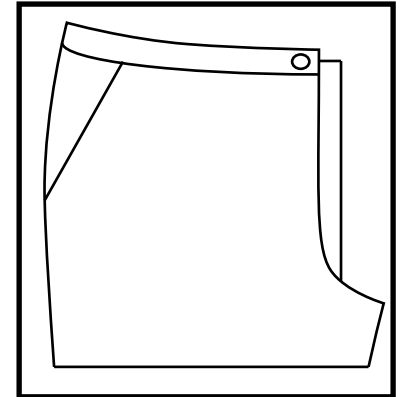

MAIN LABELS - DENIM BOTTOMS - FRONT ZIP FLY

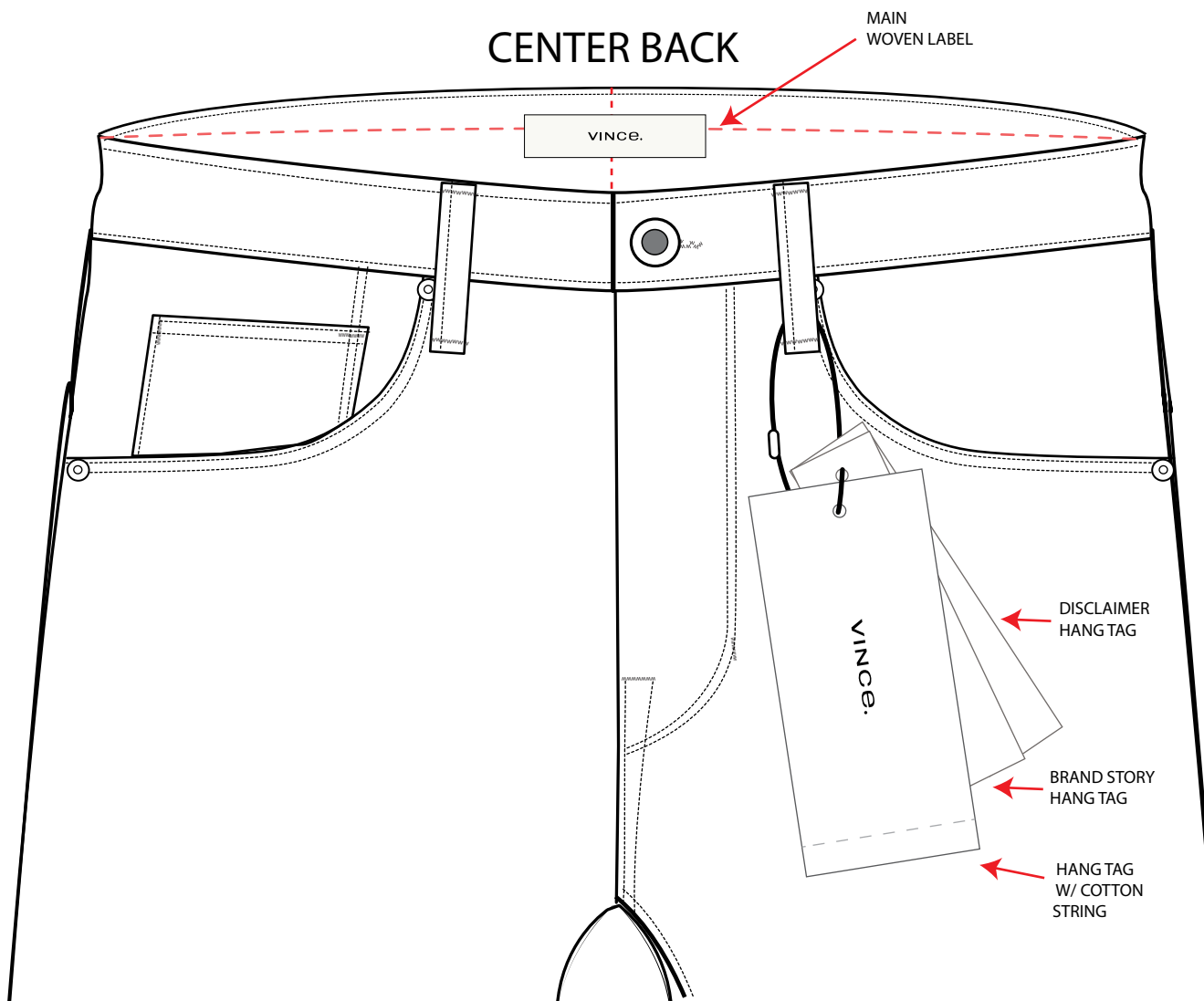

MAIN LABELS- DENIM- BACK

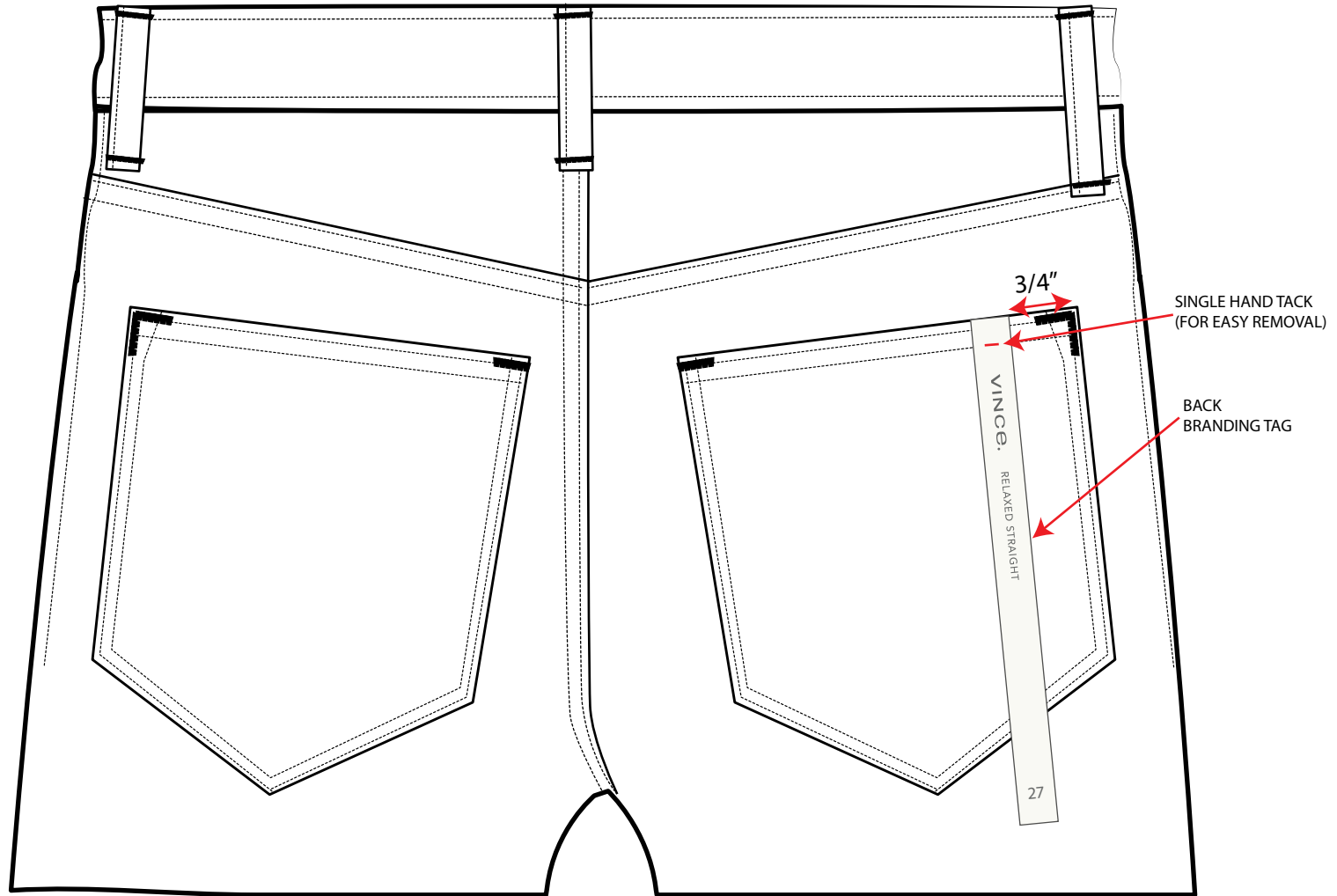

MAIN LABELS- DENIM- INSIDE FRONT

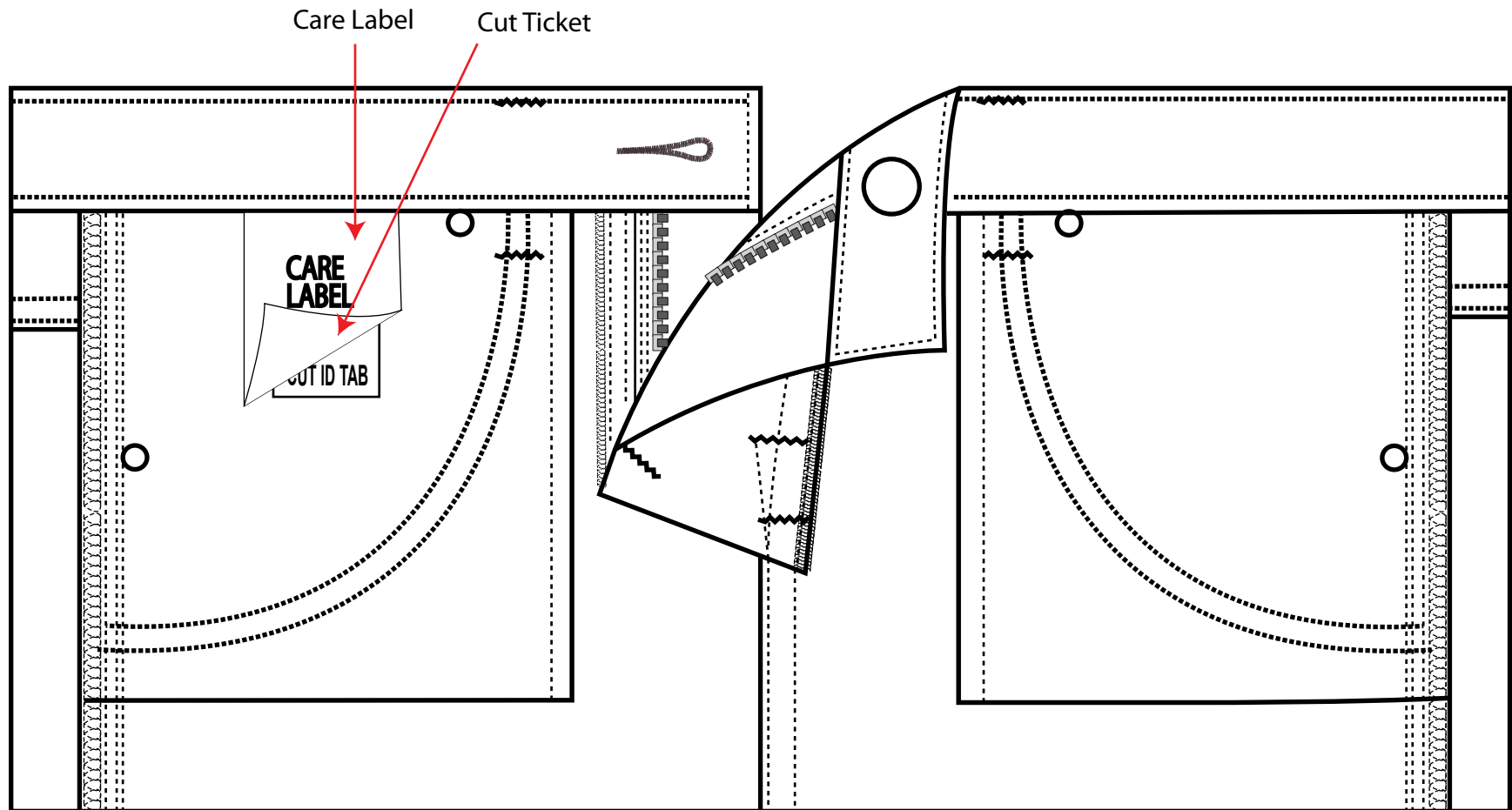

*VIEW INSIDE OUT

MAIN LABELS- KNIT SKIRTS

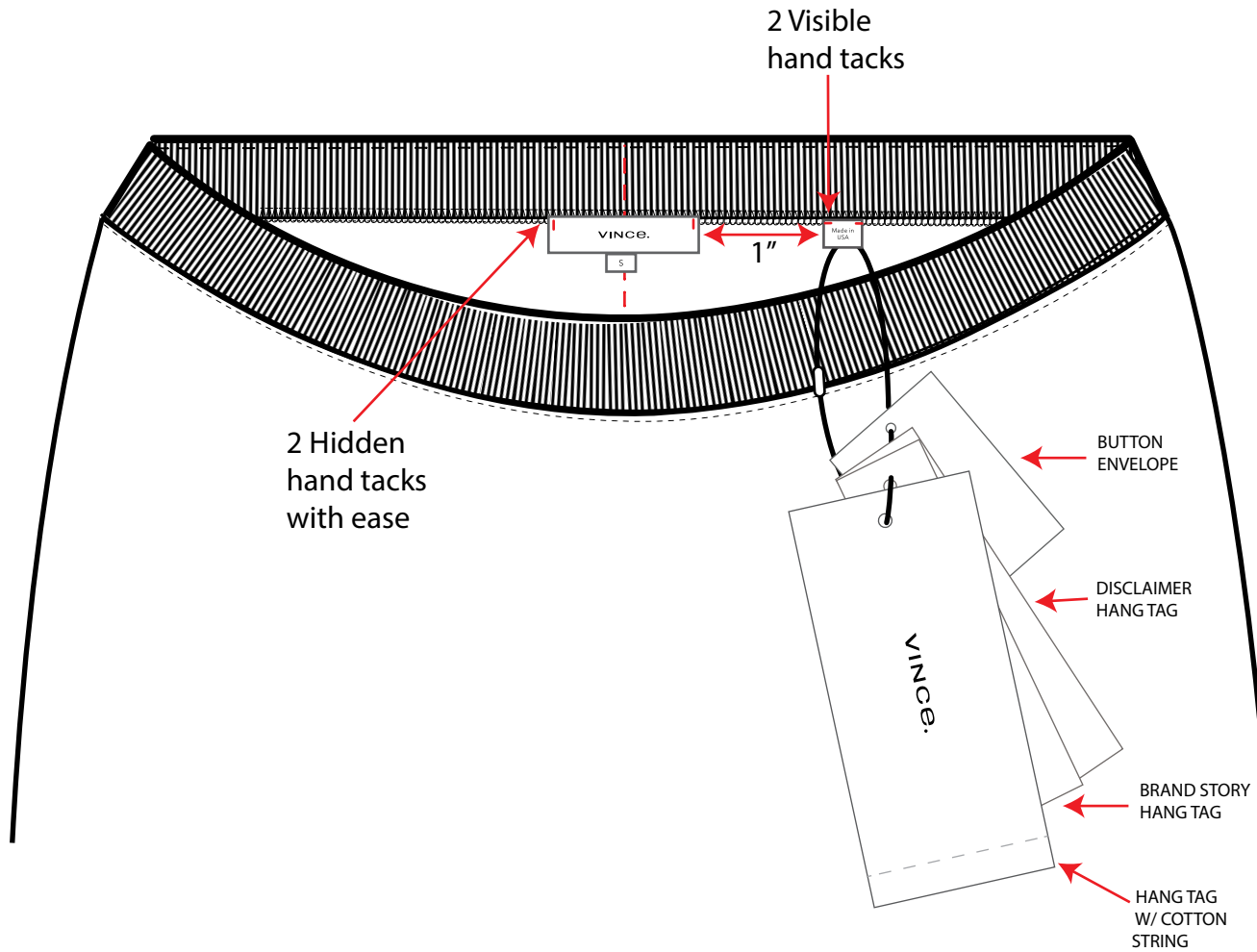

LEGEND:

Main Label



Size Label



COO Label



Hang Tag

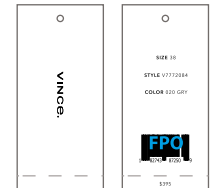

Brand Story Hang Tag



Disclaimer Hang Tag

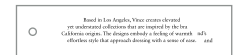

Button Envelope:

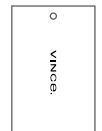

MAIN LABELS

KNIT TOPS/ MIXED MEDIA TOPS

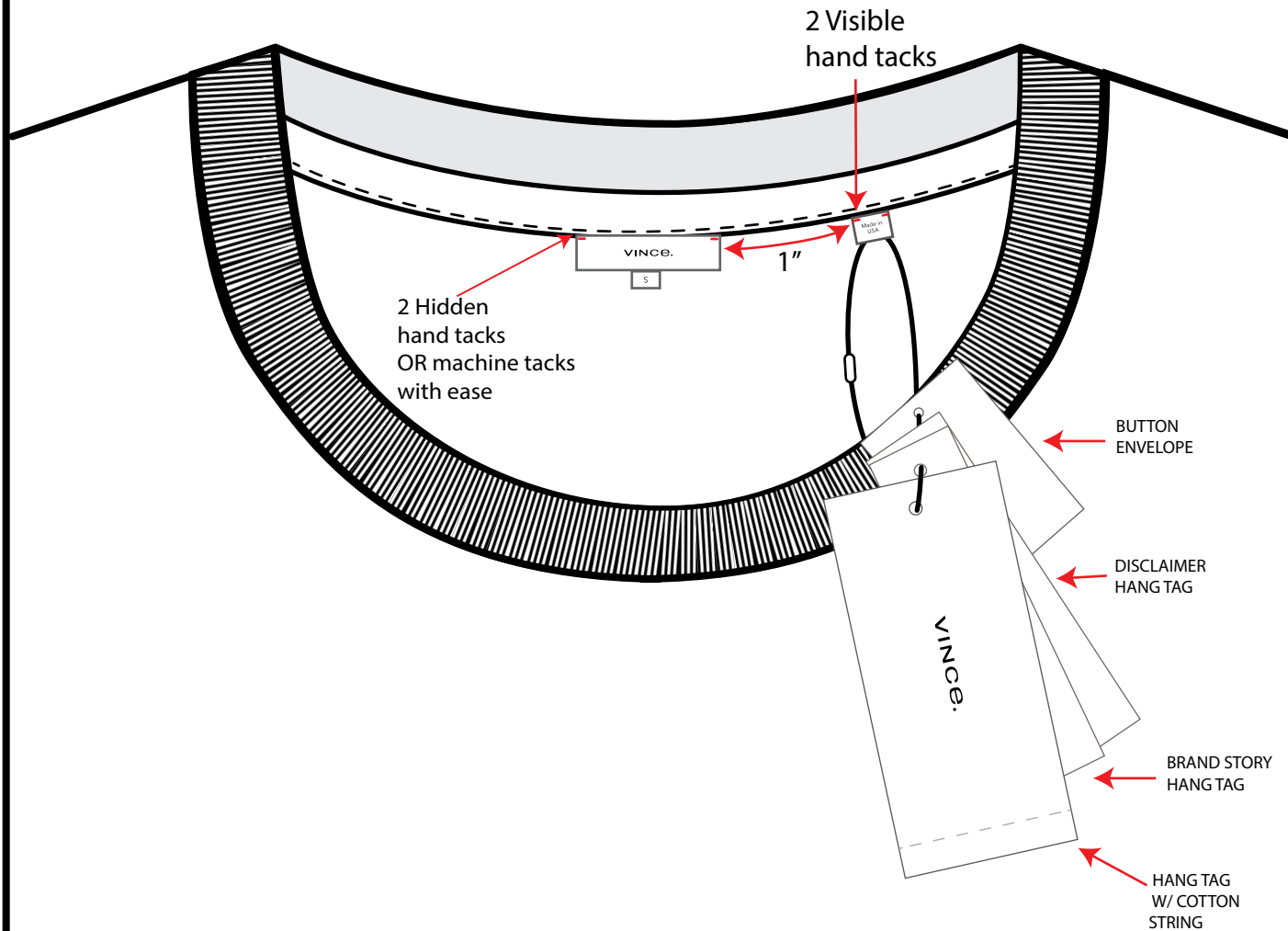

LEGEND:

Main Label: VINCE.

Size Label: S

COO Label: Made in USA

Hang Tag: VINCE. SIZE 10, STYLE V772254, COLOR 220 GRF, FPQ, 83%

Brand Story Hang Tag: BRAND STORY

Disclaimer Hang Tag: Based in Los Angeles, Vince creates elevated yet understated apparel that is inspired by the California spirit. The design reflects a laid-back attitude, with attention to the approach showing with a sense of ease and

Button Envelope: VINCE.

SCREEN PRINT PLACEMENT KNIT TOPS

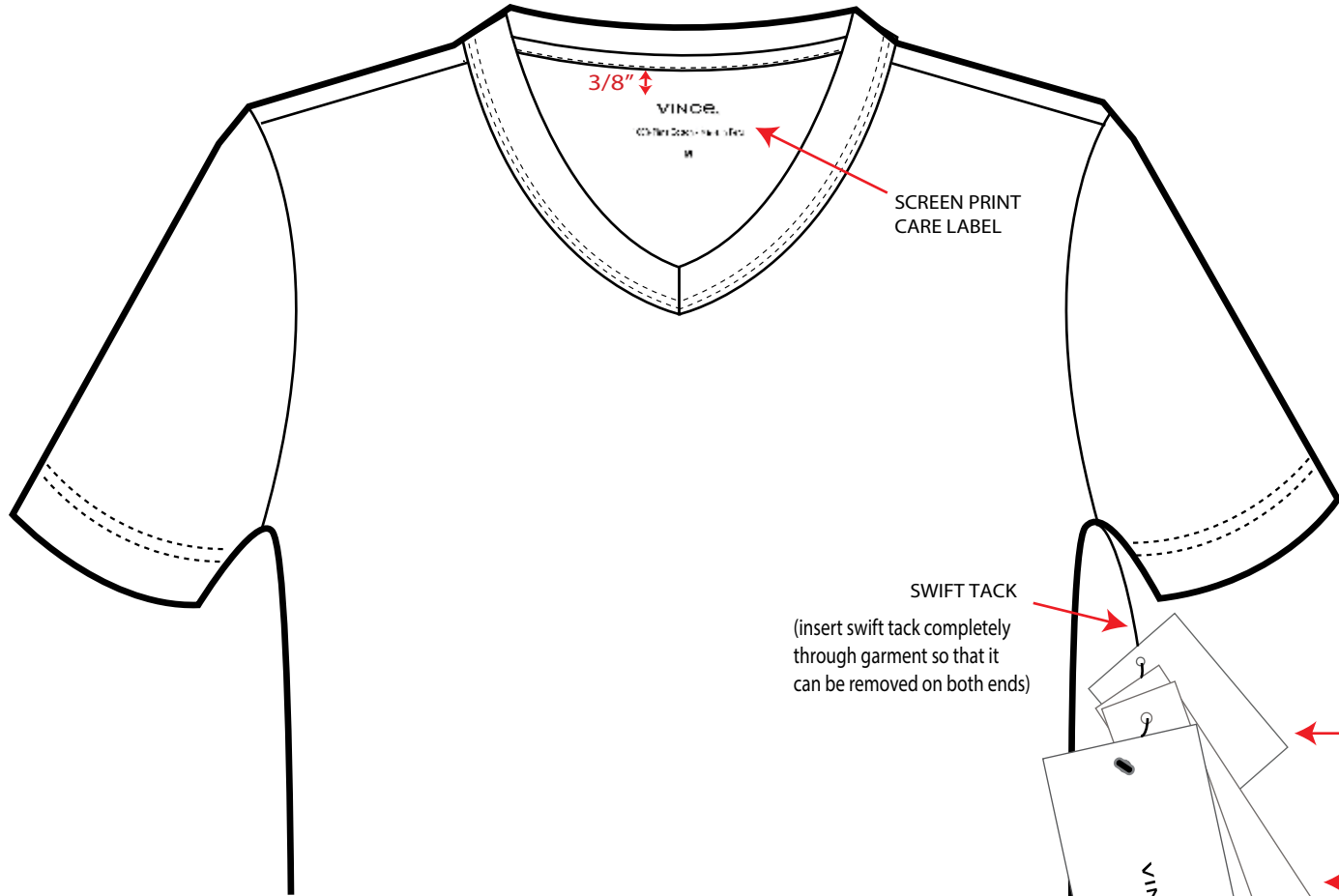

SCREEN PRINT
CARE LABEL

SWIFT TACK
(insert swift tack completely
through garment so that it
can be removed on both ends)

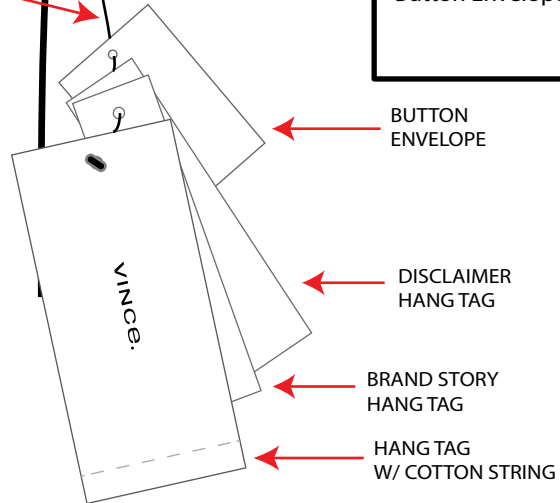

LEGEND:

Water Based Screen Print Label

Hang Tag

Brand Story Hang Tag

Disclaimer Hang Tag

Button Envelope:

VINCE.

100% Fine Cotton T-shirt

M

VINCE.

SIZE 38

STYLE 17112054

COLOR 001 GRV

3115

BRAND STORY

Brand in One Tagline: Vince creates elevated, minimalist clothing that is inspired by the California coast. The logo evokes a feeling of warmth, with attention to the approach, knowing with a sense of ease, and

Please do not remove any of the swift tacks, but if you wish to remove them, do so as follows: Please insert in the middle of the tacks and pull upwards to release the tacks. Remove all tacks and handle them with caution to avoid any sharp edges. Do not use a sharp object to remove them. When placing in a container with high collared garments, tacks or tacks-free

VINCE.

BUTTON
ENVELOPE

DISCLAIMER
HANG TAG

BRAND STORY
HANG TAG

HANG TAG
W/ COTTON STRING

SCREEN PRINT PLACEMENT KNIT TOPS WITH CB SEAM

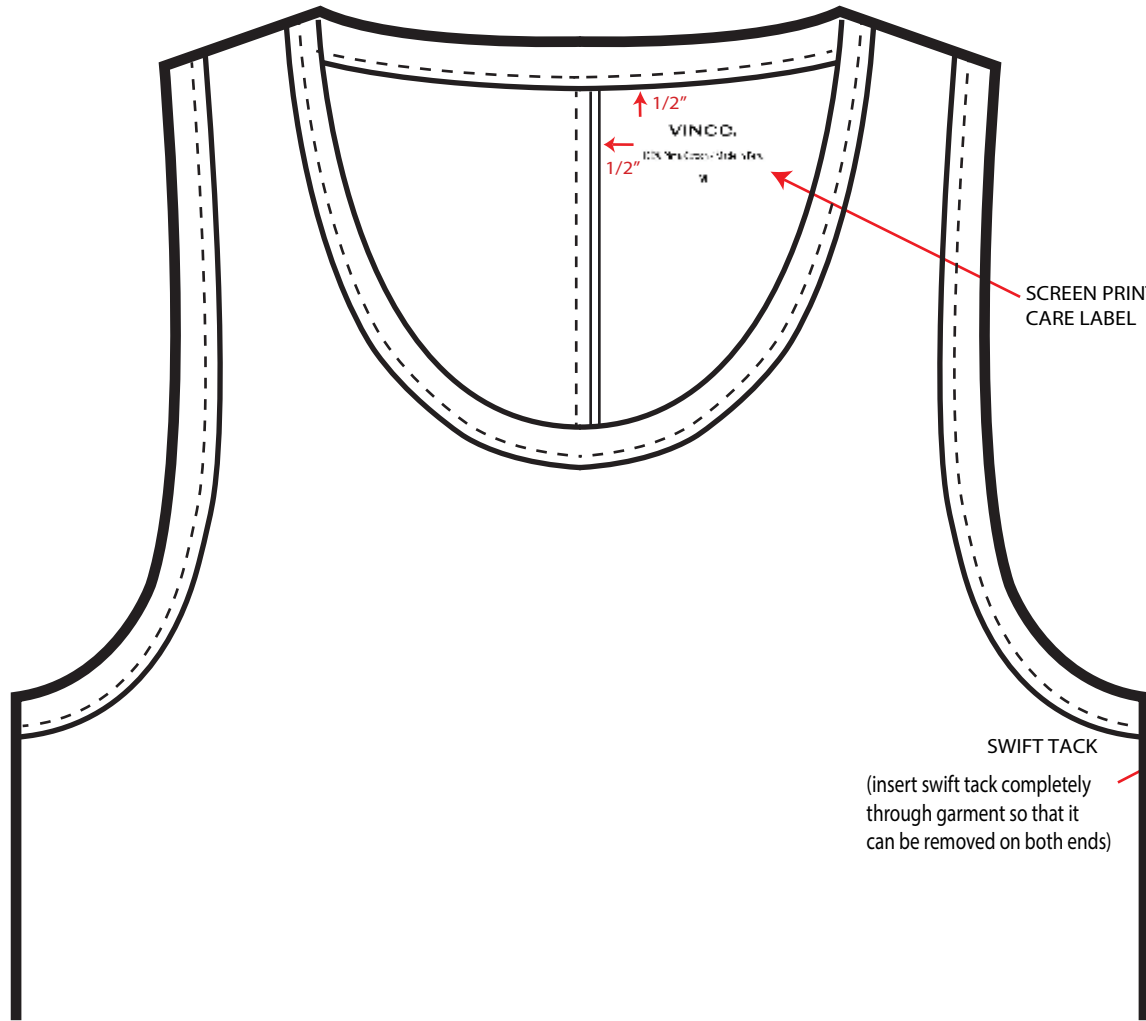

SCREEN PRINT CARE LABEL

SWIFT TACK

(insert swift tack completely through garment so that it can be removed on both ends)

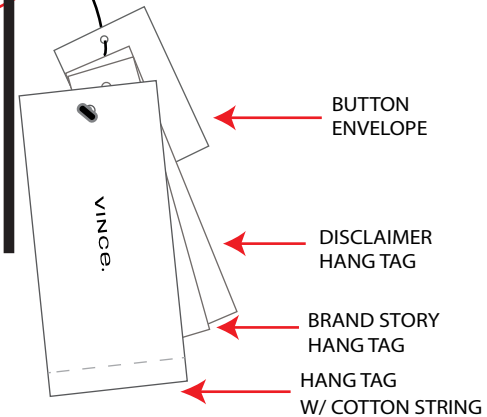

BUTTON ENVELOPE

DISCLAIMER HANG TAG

BRAND STORY HANG TAG

HANG TAG W/ COTTON STRING

LEGEND:

Water Based Screen Print Label

Hang Tag

Brand Story Hang Tag

Disclaimer Hang Tag

Button Envelope:

VINCE.

100% Premium Cotton T-shirt in Full...

M

VINCE.

SIZE 10

STYLE V777214

COLOR 020 GRP

FPQ

2014 2015

9775

BRAND STORY

Based in Los Angeles, Vince creates elevated and experimental collections that are inspired by the California spirit. The design embodies a feeling of warmth, softness and the approach of a warm blanket.

Given the inherent nature of the quality fabric, some of the color and texture from the fabric may transfer from one side of the fabric to the other. This is a natural occurrence and is not a defect. We are not responsible for any damage to your clothing caused by the use of our products.

VINCE.